

REV.		REVISIONS		DATE	APPROVED
A	ORIGINAL RELEASE			05/11/09	

**SEPARATED AND IN BYPASS MODE**

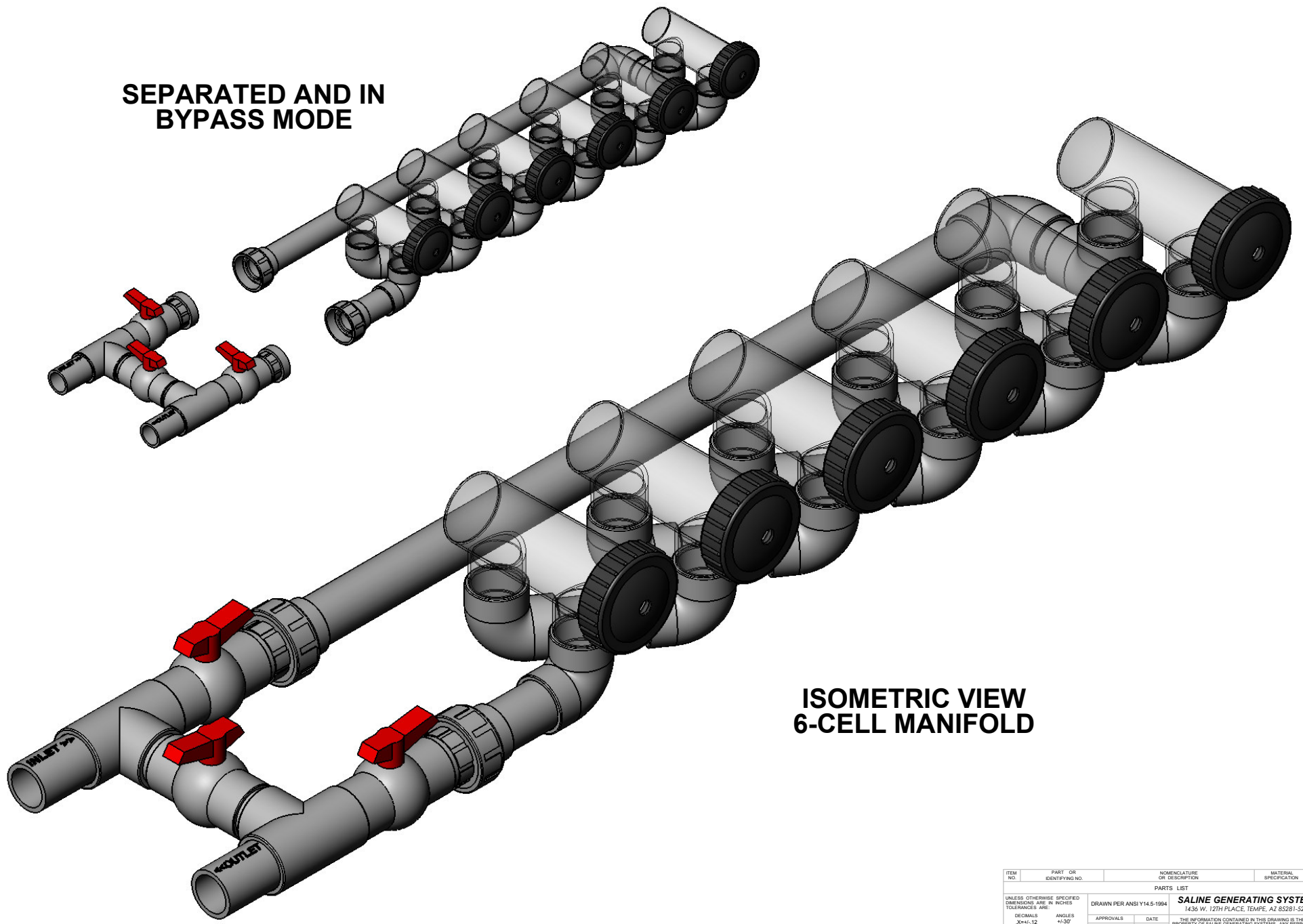

**ISOMETRIC VIEW  
6-CELL MANIFOLD**

ITEM NO.	PART OR IDENTIFYING NO.	NOMENCLATURE OR DESCRIPTION	MATERIAL SPECIFICATION	QTY	RECD
PARTS LIST					
UNLESS OTHERWISE SPECIFIED DIMENSIONS ARE IN INCHES TOLERANCES ARE:		<b>SALINE GENERATING SYSTEMS</b> 1436 W. 12TH PLACE, TEMPE, AZ 85281-5214			
DECIMALS	ANGLES	APPROVALS	DATE	<small>THE INFORMATION CONTAINED IN THIS DRAWING IS THE SOLE PROPERTY OF SALINE GENERATING SYSTEMS. ANY REPRODUCTION WITHOUT THE WRITTEN PERMISSION OF SGS IS PROHIBITED.</small> DRAWING NAME <b>SIX CELL MANIFOLD</b> SIZE/DWG. NO. <b>C</b> SCALE: 1/1" CAD FILE SHEET 1 OF 3	
.XX+/- .12	+/-30°	DRAWN	05/11/09		
.XXX+/- .05		CHECKED			
.XXX+/- .03		RESP ENG			
MATERIAL	--	MFG ENG			
FINISH	--	QUAL ENG			
DO NOT SCALE DRAWING					

REV.		REVISIONS		DATE	APPROVED
A	ORIGINAL RELEASE			05/11/09	

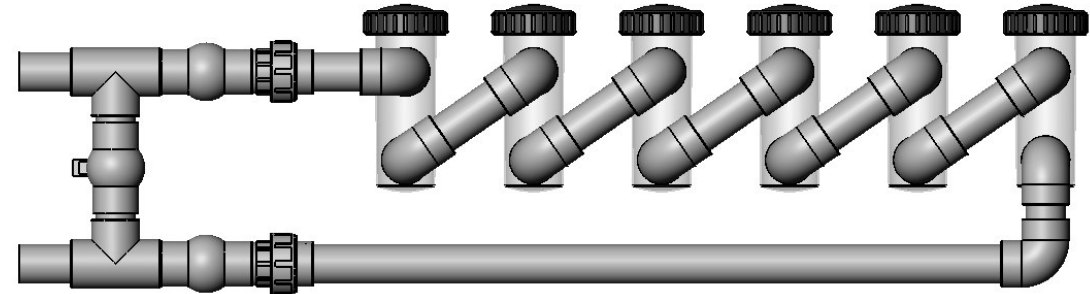
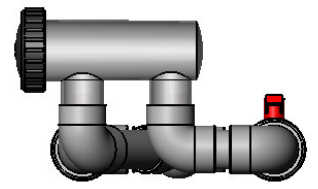
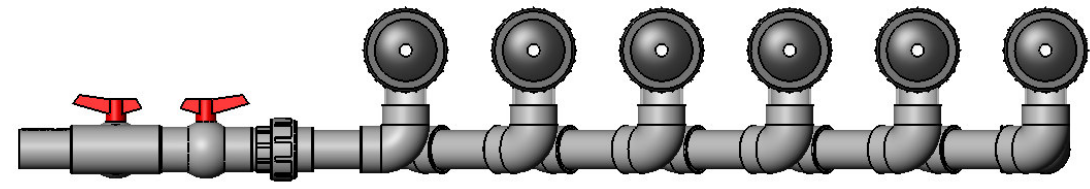
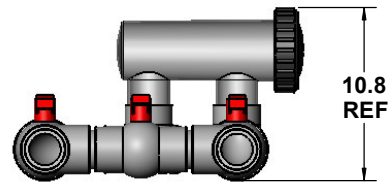
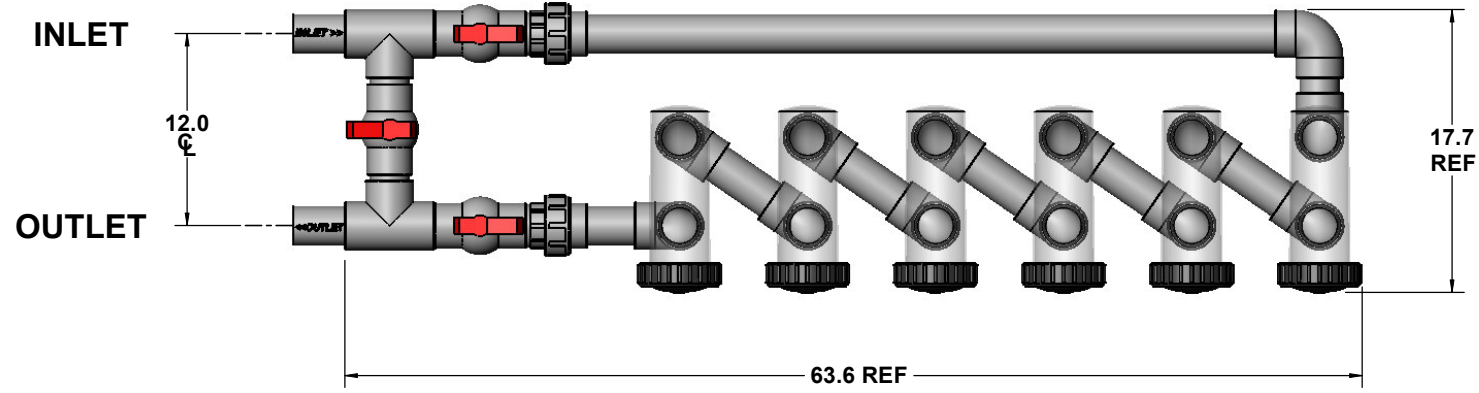

ITEM NO.	PART OR IDENTIFYING NO.	NOMENCLATURE OR DESCRIPTION	MATERIAL SPECIFICATION	QTY	RECD
PARTS LIST					
UNLESS OTHERWISE SPECIFIED DIMENSIONS ARE IN INCHES TOLERANCES ARE:					
DECIMALS	ANGLES	DRAWN PER ANSI Y14.5-1994			
.XX+/- .12	+/- 30'	APPROVALS			
.XXX+/- .03		DRAWN	DATE	THE INFORMATION CONTAINED IN THIS DRAWING IS THE SOLE PROPERTY OF SALINE GENERATING SYSTEMS. ANY REPRODUCTION WITHOUT THE WRITTEN PERMISSION OF SGS IS PROHIBITED.	
MATERIAL		CHECKED	05/11/09	DRAWING NAME	
---		RESP ENG		SIX CELL MANIFOLD	
FINISH		MFG ENG		SIZE/DWG. NO.	REV.
---		QUAL ENG		C	A
DO NOT SCALE DRAWING				SCALE: 1/1" = 1.00" FILE: CADFILE	SHEET 2 OF 3

REV.		DESCRIPTION	DATE	APPROVED
A		ORIGINAL RELEASE	05/11/09	

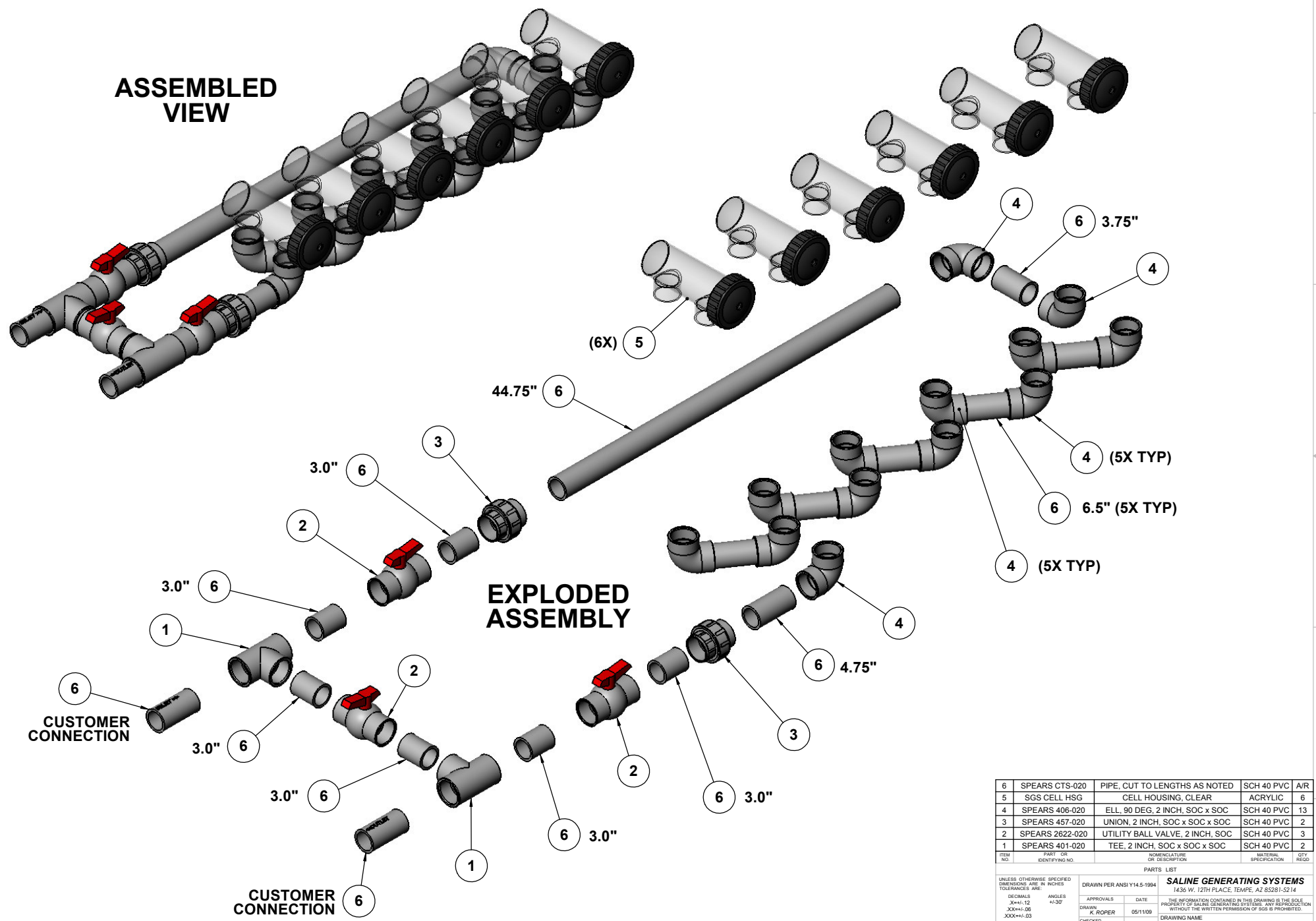

**EXPLODED ASSEMBLY**

**ASSEMBLED VIEW**

ITEM NO.	PART OR IDENTIFYING NO.	NOMENCLATURE OR DESCRIPTION	MATERIAL SPECIFICATION	QTY REQD
6	SPEARS CTS-020	PIPE, CUT TO LENGTHS AS NOTED	SCH 40 PVC	AVR
5	SGS CELL HSG	CELL HOUSING, CLEAR	ACRYLIC	6
4	SPEARS 406-020	ELL, 90 DEG, 2 INCH, SOC x SOC	SCH 40 PVC	13
3	SPEARS 457-020	UNION, 2 INCH, SOC x SOC x SOC	SCH 40 PVC	2
2	SPEARS 2622-020	UTILITY BALL VALVE, 2 INCH, SOC	SCH 40 PVC	3
1	SPEARS 401-020	TEE, 2 INCH, SOC x SOC x SOC	SCH 40 PVC	2

PARTS LIST		APPROVALS		DATE	
UNLESS OTHERWISE SPECIFIED DIMENSIONS ARE IN INCHES TOLERANCES ARE:	DECIMALS .XX+/- .12	ANGLES +/-30'	DRAWN	K. ADOPER	05/11/09
	.XXX+/- .03		CHECKED		
MATERIAL	--	RESP ENG			
FINISH	--	MFG ENG			
DO NOT SCALE DRAWING	QUAL ENG				

SALINE GENERATING SYSTEMS		1436 W. 12TH PLACE, TEMPE, AZ 85281-5214	
DRAWING NAME			
<b>SIX CELL MANIFOLD</b>			
SIZE	DWG. NO.	REV.	
C	SGS 6 CELL	A	
SCALE	1/1" CAD FILE	CAD FILE	SHEET 3 OF 3